

SIMPLY CLEVER

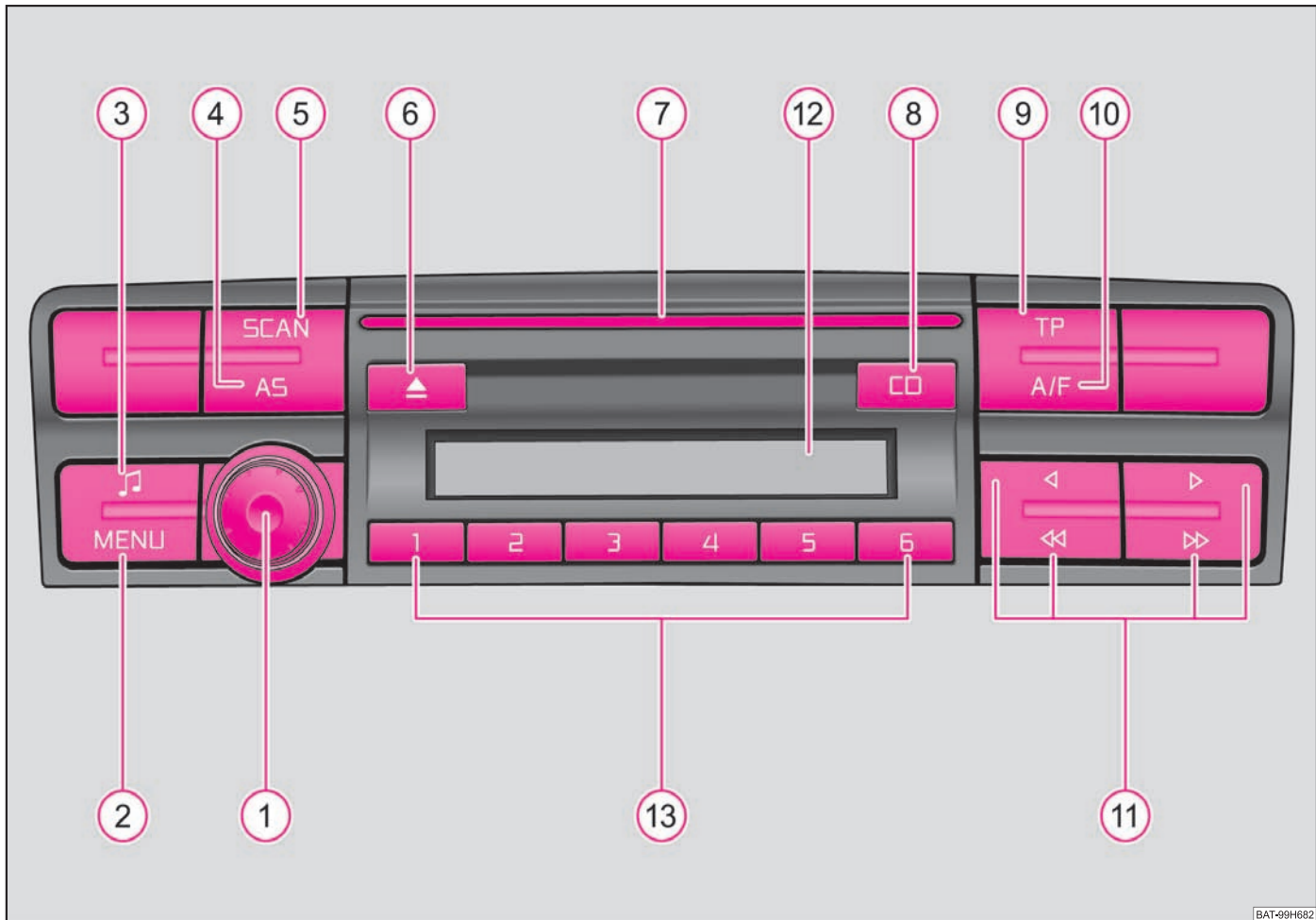

**ŠkodaAuto**

CAR RADIO BLUES



# Contents

<b>Radio</b> .....	2
Radio - Overview .....	2
Important information .....	2
Anti-theft protection .....	3
Basic setting .....	3
Radio mode .....	5
<b>CD player</b> .....	7
Using the system .....	7

## Radio

### Radio - Overview

---

- ① Rotary/push knob
  - switching on and off (pressing)
  - Volume control (rotate)
  - other function settings in various menus
- ② Rocker switch (MENU) to call up the menu settings of the parameter for radio or CD player
- ③ Rocker switch (P) for adjusting the sound
- ④ Rocker switch (AS) to automatically store the station
- ⑤ Rocker switch (SCAN) to activate the AM radio mode
  - fast search in the respective waveband
  - Scroll through the contents of the CD
- ⑥ CD - eject button
- ⑦ CD-case
- ⑧ Button (CD) to activate the CD mode
- ⑨ Rocker switch (TP) to activate the reception of traffic reports
- ⑩ Rocker switch (A/F) to switch over between the wavebands AM/FM
- ⑪ Rocker switches (◀ ▶ ◀▶ ▶▶)
  - manual station finding, fast station finding
  - Select the track in the CD mode, fast forward/backward search in the CD mode
  - Selecting the menu points
- ⑫ Display
- ⑬ Station keys (1) - (6)
  - store and select the RDS station
  - CD selection
  - Enter code

#### Characters in the text

\* Parts of the equipment which are marked in such a way are only installed as standard on certain models or are available as special equipment.

■ End of the paragraph.

▶ The paragraph continues on the following page. ■

### Important information

#### Warranty

---

The equipment warranty terms and conditions also apply for new vehicles.

After the expiration of the warranty, a piece of equipment in need of repair will be replaced with a reconditioned, original item with spare part warranty. It is, however, a precondition that the housing has not been damaged and no unauthorised attempts have been made to carry out repairs.

#### Note

Damage within the meaning of the warranty must not be the result of improper handling of the system or from unprofessional repair attempts. It is also essential that there is no external damage. ■

#### Operation of radio

---

##### **The radio should only be used, if the traffic situation permits it.**

The volume settings must be selected in such a way that audible signals from the outside, e.g. a Martins horn from utility vehicles (police cars, ambulances and fire brigade), can be heard at all times.

#### Power output

4x20 W



## WARNING

**Please concentrate fully at all times on your driving! As the driver you are fully responsible for road safety. Only use the functions of the radio in such a way that you are always in full control of your vehicle in all traffic situations! ■**

## Using the display

Carefully handle the display because dents and scratches can occur through pressure of the finger or contact with sharp objects.

The display can be cleaned with a soft cloth and finger marks can be wiped away with pure alcohol.

## Note

Do not use solvent such as turpentine or petrol as they will corrode the display surface. ■

## Anti-theft protection

### Anti-theft coding

Your radio is equipped with a convenience coding. If the radio is being operated for the first time, the safety code is not only stored in the radio but also in the vehicle.

After disconnecting and reconnecting the battery, first of all switch on the ignition and then the radio.

If you wish to install the radio in another vehicle, the safety code must be entered. In this case, please do not hesitate to contact a Škoda Service Partner or a Škoda importer.

As the unit only functions after entering the safety code, this practically excludes its use after a theft - a contribution to increased anti-theft safety.

## Note

The code is stored in the instrument cluster. This ensures that it is automatically decoded (convenience coding). Manual input of the code is normally not necessary. ■

## Enter code

- Switch on the radio if the ignition is on. **SAFE** is displayed and then **1000**.
- Enter the safety code using the station keys **1** - **4**.
- Confirm the safety code by pressing the station key **6**.

If you have confirmed a wrongly entered code, you can repeat once again the entire process.

If the code number is entered incorrectly for the second time, the unit will be blocked for approx. one hour. It is possible to enter again the safety code after one hour has expired, when the unit and the ignition have been switched on.

The cycle - two attempts, blocked for an hour - will continue to apply. ■

## Basic setting



### Switching the unit on and off

- The system is switched on or off by turning / pressing the rotary / push knob **1**.

If the key is pulled out of the ignition lock with the unit switched on, the unit will switch off automatically. You can switch on again the unit by pressing the rotary/push knob **1**. When the ignition is switched off, the unit switches off automatically after approx. one hour (discharge protection of the vehicle battery). ►

If you have switched off the radio by withdrawing the ignition key, the radio switches on again once the ignition is on. ■







## Audio settings

- Press the rocker switch  repeatedly to select the desired parameter.
- Set the desired value by turning the rotary/push knob .

You can select between the following parameters:

- **TRE** - Treble setting;
- **BASS** - bass setting;
- **BAL** - setting of the volume ratio between the left and the right side;
- **FAD** - setting of the volume ratio between the front and the rear; ■

## Setting the special functions

- Press the rocker switch , in order to activate the menu Set-up.
- Individual functions of the menu are selected by pressing the rocker switch  or by pressing the rocker switches    .
- Set the desired value by turning the button .

### REG AUTO / REG OFF

Certain programs of the broadcasting companies are divided into regional programs at specific times. That is why in individual regions the regional programs of a station can broadcast different contents.

First of all the unit attempts to set only alternative frequencies of the selected station.

If the quality is however so low, that there is a risk of a “program loss”, the unit also accepts “related” frequencies.

When opting for **REG AUTO** the change to a regional “related” station can only be performed if there is a risk of losing the station. When selecting **REG OFF**, the receiver can access the regional “related” stations unlimited.

### GALA

Your radio increases automatically its volume with the increasing vehicle speed. A higher setting value results in a stronger volume increase.

### LOUD

In case of low volume level, the function reinforces the range of bass and treble frequencies.

### BEEP

Switching on or off the tone signal when storing the radio stations.

### ON VOL

Your radio stores the last volume set before switching off. If the value is higher, the volume is reduced to the value of the parameter **ON VOL** after switching on the radio again.

### PHONE\*

If your vehicle is equipped with a handsfree system, the monophone play function of the mobile phone calls is carried out via the loudspeakers of the vehicle.

### PDC AT\*

If your vehicle is equipped with “parking aid”, the volume is automatically decreased to a pre-defined value, when the “parking aid” is active.

- **PDC AT0** - does not restrict the volume;
- **PDC AT1** - restricts the current volume to a middle level;
- **PDC AT2** - restricts the current volume to a low level;
- **PDC AT3** - switches off the tone completely (Mute).

### AUX\*

Setting of the input sensitivity **AUX LEV**:

- **AUX LEV 1** - high level, used in particular for notebooks;
- **AUX LEV 2** - middle level, used for cassettes or CD player;



- **AUX LEV 3** - low level, used for MP3 player;



### Note

Each setting change is stored by changing to another menu point. ■

## Radio mode

### Waveband switch-over

---

Your radio is fitted with the wavebands FM and AM, in order to change, press the rocker switch **[A/F]** for some considerable time.

In the ranges FM1/AM1 and FM2/AM2 there are each 6 memory spaces available, in order to change, press the rocker switch **[A/F]** briefly. ■

### The process of searching for and storing the radio stations

---

#### Manual search

- Set the frequency of the desired radio station by pressing the rocker switch **[◀]** or **[▶]**.

#### Automatic station finding SEEK

- The radio searches for the next radio station in the selected waveband by pressing the rocker switch **[◀◀]** or **[▶▶]**.

#### Function SCAN

- The radio station of the current waveband is briefly played (10 seconds) by pressing the rocker switch **[SCAN]**.
- This function is ended by pressing the rocker switch **[SCAN]** once again and the current station is replayed.

#### Store station

- After selecting the radio station, hold the station key **[13]**, on which it should be stored until it briefly switches to mute and a brief signal sounds.

#### Automatic station finding with storing the radio stations

- Press the rocker switch **[AS]**. An automatic station finding is started during which the 6 stations with the strongest signal in the memory level FM2 and/or AM2 are stored. **STORE** is displayed on the display. This applies only to the wavebands FM2 and AM2.

When storing the radio stations on the station keys **[13]** is finished, you can call up the desired radio station by pressing a station key **[13]**.



### Note

The stored radio stations of the current waveband are updated and stored once again by repetitively pressing the rocker switch **[AS]**. ■

### Radio text

---

Certain radio stations transmit additional text information - designated as radio text.



### Note

- The text information must not be available to all radio stations.
- Depending upon the quality of the received signal, the radio needs a specific time, in order to correctly read all the illustrated characters. ■

## Traffic reports

---

### Activating and deactivating the traffic reports

Press the rocker switch , **TP** appears in the display. If a set radio station does not transmit a traffic report, the radio searches for a station which transmits the traffic report. **TP SEEK** is displayed on the display.

If no radio station which transmits the traffic reports is found, **NO TP** is shown on the display.

An incoming traffic report automatically interrupts the CD play function or listening to a radio station, which at that moment is not transmitting a traffic report. **INFO and Station name** is shown on the display. At the end of the traffic report, the radio automatically returns to the original play function.

If you wish to deactivate the traffic information, press once again the rocker switch , **TP** goes out on the display. ■



## CD player

### Using the system

#### Inserting the CD

- Press the button **[CD]**, in order to select the source for the play function: **CD** (internal CD drive), **EXT** (CD changer, if it is connected to the radio) or **AUX**.
- Carefully insert a CD into the CD case **(7)** until it is automatically drawn in. The play function begins automatically. ■

#### Operating the CD player

##### Audio CD: Select track

- Press the rocker switch **[◀]** or **[▶]** during the play function of the CD, in order to select the previous and/or the next title.
- Press the rocker switch **[◀◀]** or **[▶▶]** for a longer period of time for fast reverse or forward replay of the track. The play function is continued after releasing the button.

##### MP3 Data: Select track

- Press the rocker switch **[◀]** or **[▶]** during the play function of the CD, in order to select the previous and/or the next title.
- Press the rocker switch **[◀◀]** or **[▶▶]** for a longer period of time for fast reverse or forward replay of the track. The play function is continued after releasing the button.
- Briefly press the rocker switch **[◀◀]** or **[▶▶]** for scrolling in the folders or in the play lists (if they are present on the CD).

##### Function SCAN

- Press the rocker switch **[SCAN]**, in order to scroll through the CD. The first 10 seconds of each title are played.
- In order to return to the normal mode, press once again the rocker switch **[SCAN]**.
- Press the rocker switch **[◀]** or **[▶]** if you wish to select the previous or the following track.

##### End the play function of the CD

- In order to end the play function of the CD and to activate the radio, press the rocker switch **[A/F]**. The CD remains in the unit.

##### Ejecting CD

- Press the button **(6)**, the Cd is ejected.

##### Display of additional information (MP3 data)

In the display, you can select the display of additional information via the MP3 data using the station keys **[1]** - **[6]**:

- **[1]** - Number of the folder and number of the track;
- **[2]** - Name of the track;
- **[3]** - Name of the performer;
- **[4]** - Name of the album;
- **[5]** - Name of the data;
- **[6]** - Name of the folder.



##### Note

- If the ejected CD is not removed, it is drawn in again for safety reasons.
- If the radio is functioning in the TP mode before changing to the CD mode, the play function of the CD is interrupted during the traffic reports and the unit ▶

switches over to the radio mode. After the traffic reports have ended, the unit switches back once again to the CD mode. ■

## Replay the tracks in random order

- Press the rocker switch **[MENU]**, in order to activate the menu Set-up.
- Select a function of the **MIX** menu with the help of the station keys.
- Set the desired value by turning the button **1**.

### MIX

Play function of titles in random order.

- **MIX OFF** - the function of the menu is switched off;
- **MIX CD** - Plays the tracks on a CD in random order;
- **MIX FLD** - Play function of titles in random order in a certain (folder);
- **MIX PLS** - Play function of the playlist (folder of selected tracks from individual folders, which is stored on the CD). Is only displayed when a playlist is created for the replayed CD. ■

## General information for MP3 operation

### Requirements for the MP3 data and data carrier

- 650 MB and 700 MB CD-ROM, CD-R, CD-RW.
- The CDs must correspond to the ISO 9660 Level 2 standard as well as the Joliet data system (single and multi-session).
- Data names must be no longer than 64 characters.
- The list structure is restricted to a depth of 8 list levels.
- The name of the artist, the album and the title of the reproduced MP3 data can be shown as ID3 tag, providing this information is available. The list and data name will be displayed if there is no ID3 tag.
- Play lists are not supported.

### Bit rate (data flow per time unit)

- The system supports MP3 data with bit rates of 32 to 320 KB/s as well as MP3 data with variable bit rates.
- The indicated playing time data with variable bit rates is not reliable. ■

## Playing sequence of MP3 data and folders

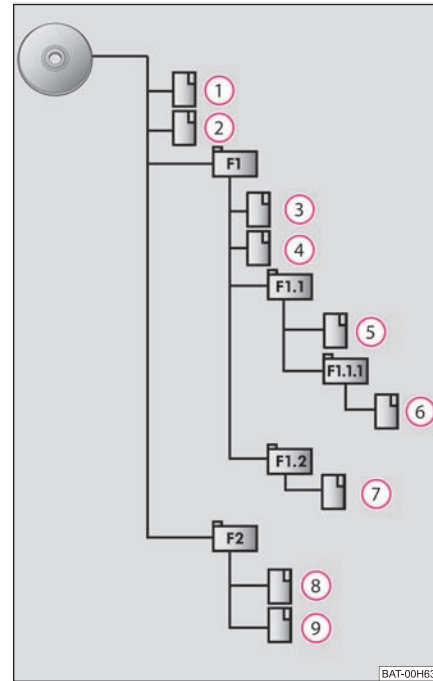



Fig. 1 Playing sequence of MP3 data and folders

The unit plays the MP3 data stored on a data carrier in a certain sequence ⇒ page 8, fig. 1. The illustration shows an example of a typical MP3 CD containing the titles (Tracks ) , folder (Folder ) and sub-folder. ■

## Information on how to use a CD

### CD to jump

Uneven road surfaces and strong vibrations may cause the CD to jump.

### Formation of condensation

When it is cold and after rain showers, moisture can deposit in the CD drive (condensation). This can effect the CD jump or impair the play function. In such cases wait until the moisture has dissipated.

### Notes for the care of the CDs

If a CD is soiled, please never clean the CD in the direction of a circle but rather from inside to outside with a soft lint-free cloth. In case of severe layers of dirt we recommend to clean the CD with a commercially available CD cleaner. Also in this case do not clean the CD in the direction of a circle but rather from inside to outside and then let it dry off.

### Overheating protection

If the temperature in the unit exceeds 85°C, the play function of the CD is ended for safety reasons.



### Caution

- Never use liquids such as gasoline, paint thinner or disk cleaner, otherwise the surface of the CD could get damaged!
- Never expose the CD to direct sun rays!
- Please never write or affix the CD!



### Note



Dirt or damage of a CD can lead to difficulties when “reading” the information. The difficulty in reading the error depends on the dirt or on the severity of the mechan-

ical damage. Severe scratches cause reading errors which can make the CD jump or “get stuck”. All CDs must be treated carefully and always be stored in a protective case. ■



## Input AUX-IN\*

The input for external audio sources AUX-IN is located below the armrest of the front seats and is marked with the logo **AUX**.

### Activating an external audio source

- Press the button  and once again the button  in order to select the external input. The play function starts automatically after connecting the external source.

### End play function of the external source

- Press the rocker switch . It starts the play function of the last selected radio station.
- Press the button  and select the CD source for the play function.

An external audio source connected to the AUX-IN socket is merely replayed via the radio and the loudspeakers. The external audio sources **cannot** be controlled via the radio.

You can select another audio source on the radio at any time. As long as the external audio source is not switched off, it remains always active in the background.

Please refer to the Owner's manual of the respective manufacturer for the operation of the external audio source.

Use the standard jack plug 3.5 mm for the AUX-IN socket. If the external audio source does not have this jack plug, you must use an adapter.

### Adjust the play function volume of the external audio source

The play function volume of the external audio source can be changed via the volume control on the radio. ▶

Depending on the connected audio source the output volume on the external audio source can be changed.

You can also change the input sensitivity of the AUX-IN socket ⇒ page 4 in order for the play function volume of the external audio source to adapt to other audio sources or to avoid distortions of the play function volume.

### WARNING

- **On no account place an external audio source on the dash panel. You could make sudden manoeuvres in the passenger compartment and injure the occupants.**
- **On no account place an external audio source close to the airbags. You could be thrown back in the passenger compartment by the airbags being deployed and injure the occupants.**
- **You must not hold the external audio source in the hand or on the knees while driving. You could make sudden manoeuvres in the passenger compartment and injure the occupants.**
- **Always guide the connection cable of the external audio source in such a way that it does not restrict you when driving.**

### Caution

The AUX-IN socket must only be used for audio sources!

### Note

- Your radio has no control over the level setting of the external source. Make sure that the highest quality is achieved by a suitable combination of input sensitivity and output sensitivity of the external source (volume control). You will find detailed information for this setting in the operating instructions of the units.
- If an external audio source is connected via AUX-IN, which is equipped with an adapter for external power supply, it can occur that the audio signal is interrupted. This depends on the quality of the adapter which is used.
- The loudspeakers in the vehicle are matched to a power output of the radio of 30<sup>o</sup>W. ■

Škoda Auto pursues a policy of constant product and model development. We trust that you will understand that changes to models in terms of shape, equipment and engineering, may be introduced at any time. The information about scope of delivery, appearance, performances, dimensions, weight, fuel consumption, standards and functions of the vehicle is only correct at the time of publication. Certain items of equipment might only be installed later on (information given by the local authorised Škoda Service Partner) and only envisaged for particular markets. It is therefore not possible for legal claims to be made based on the data, illustrations and descriptions contained in this Owner's Manual.

Reprinting, reproduction or translation, either in whole or in part, is not permitted without the written consent of Škoda Auto.

Škoda Auto expressly reserves all rights relating to copyright laws.

We reserve the right to make changes to this document.

Issued by: ŠKODA AUTO a.s.

© ŠKODA AUTO a.s. 2009

[www.skoda-auto.com](http://www.skoda-auto.com)

Autorádio Blues  
Octavia, Yeti anglicky 05.09  
S00.5610.63.20  
1Z0 012 149 CD